



SP

MEC

D2 = 97 - n max 8000
D2 = 117 - n max 7000

397 - C

Il set è composto da:

- 1 Testa portacoltelli Art 394-T Z = 2 ;
- 14 Coppie di coltelli B = 48 a = 5.5 ;
profilo 141 - 161A - 161B - 162 - 163A -
163B - 164A - 164B - 165A - 165B - 165C -
166A - 166B - 166C ;
- 1 Pietra ad olio per l'affilatura ;
- 1 Contenitore in materiale plastico.

397 - R

Il set è composto da:

- 13 Coppie di coltelli B = 48 a = 5.5 ;
profilo 161A - 161B - 162 - 163A - 163B -
164A - 164B - 165A - 165B - 165C - 166A -
166B - 166C ;
- 1 Pietra ad olio per l'affilatura ;
- 1 Contenitore in materiale plastico.



ART

d

COD. SET

397 - C

30

0397C09730

397 - C

31.75

0397C09731

397 - C

35

0397C09735

397 - C

40

0397C11740

397 - C

50

0397C11750

397 - R

0397R00000



Set multi - profile 397 - C.

The set includes :

- 1 Cutter head Art 394-T Z = 2 ;
- 14 Pairs of knives B = 48 a = 5.5 ;
ref. 141 - 161A - 161B - 162 - 163A - 163B - 164A - 164B -
165A - 165B - 165C - 166A - 166B - 166C ;
- 1 Sharpening oil stone ;
- 1 Plastic case.

Set multi - profile 397 - R.

The set includes :

- 13 Pairs of knives B = 48 a = 5.5 ;
ref. 161A - 161B - 162 - 163A - 163B - 164A - 164B - 165A -
165B - 165C - 166A - 166B - 166C ;
- 1 Sharpening oil stone ;
- 1 Plastic case.



Estuche multiperfiles 397 - C.

El juego comprende :

- 1 Cabezal Art 394-T Z = 2 ;
- 14 Pares de cuchillas B = 48 a = 5.5 ;
ref. 141 - 161A - 161B - 162 - 163A - 163B - 164A - 164B -
165A - 165B - 165C - 166A - 166B - 166C ;
- 1 Afiladora ;
- 1 Estuche de plàstica.

Estuche multiperfiles 397 - R.

El juego comprende :

- 13 Pares de cuchillas B = 48 a = 5.5 ;
ref. 161A - 161B - 162 - 163A - 163B - 164A - 164B - 165A -
165B - 165C - 166A - 166B - 166C ;
- 1 Afiladora ;
- 1 Estuche de plàstica.



Coffret multiprofiles 397 - C.

Le jeu comprend :

- 1 Porte - outils Art 394-T Z = 2 ;
- 14 Paires de couteaux B = 48 a = 5.5 ;
réf. 141 - 161A - 161B - 162 - 163A - 163B - 164A - 164B -
165A - 165B - 165C - 166A - 166B - 166C ;
- 1 Pierre à l'huile pour l'affûtage ;
- 1 Coffret en plastique.

Coffret multiprofiles 397 - R.

Le jeu comprend :

- 13 Paires de couteaux B = 48 a = 5.5 ;
réf. 161A - 161B - 162 - 163A - 163B - 164A - 164B - 165A -
165B - 165C - 166A - 166B - 166C ;
- 1 Pierre à l'huile pour l'affûtage ;
- 1 Coffret en plastique.



Multi - Profil Satz 397 - C.

Der Satz besteht aus :

- 1 Messerkopf Art 394-T Z = 2 ;
- 14 Messerpaaren B = 48 a = 5.5 ;
Profil 141 - 161A - 161B - 162 - 163A - 163B - 164A - 164B -
165A - 165B - 165C - 166A - 166B - 166C ;
- 1 Schleifölstein ;
- 1 Plastiketuì.

Multi - Profil Satz 397 - R.

Der Satz besteht aus :

- 13 Messerpaaren B = 48 a = 5.5 ;
Profil 161A - 161B - 162 - 163A - 163B - 164A - 164B -
165A - 165B - 165C - 166A - 166B - 166C ;
- 1 Scheifhölstein ;
- 1 Plastiketuì.



d	D2	D MAX
30	97	146
31.75	97	146
35	97	146
40	117	167
50	117	167

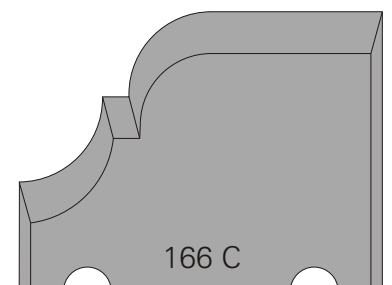
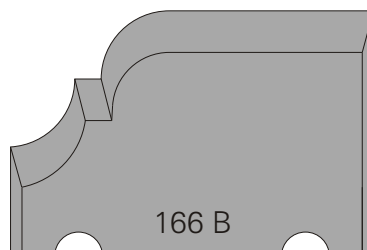
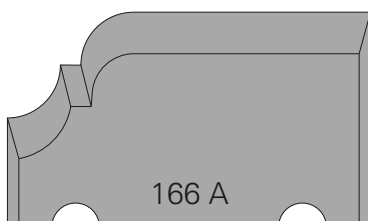
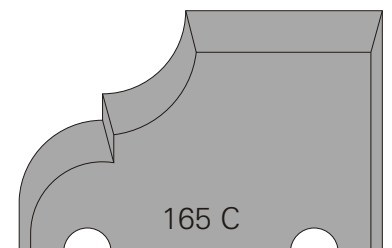
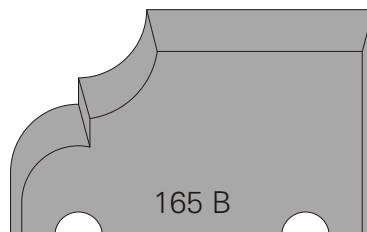
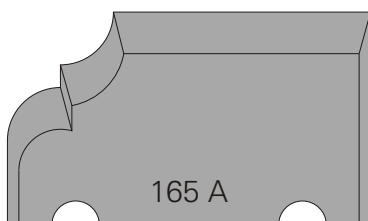
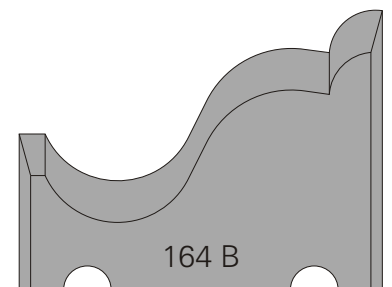
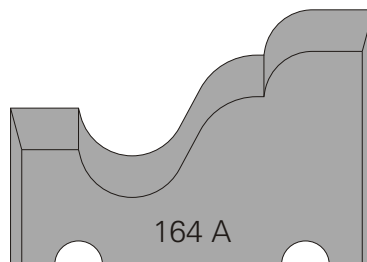
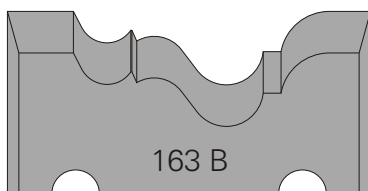
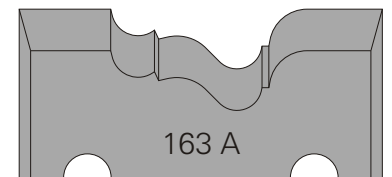
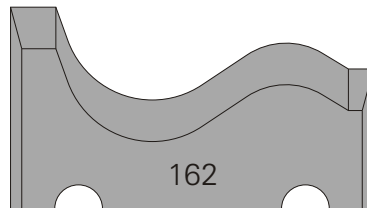
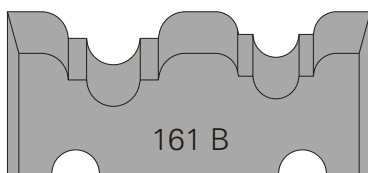
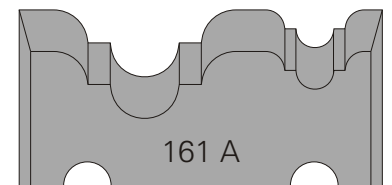
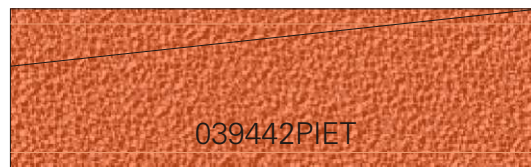
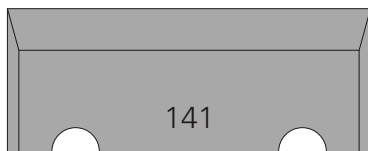
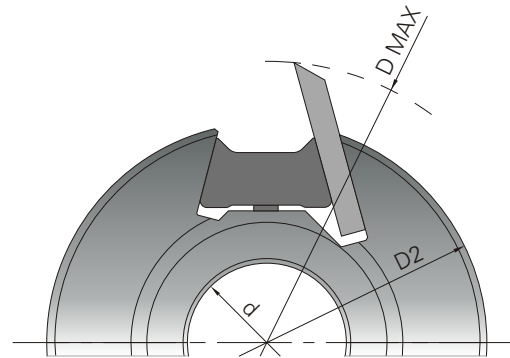



SP

MAN

D2 = 97 - n 6000 - 8000
D2 = 117 - n 5900 - 7000

K 397 - C

- Il set è composto da:
- 1 Testa portacoltelli Art K 394-T Z = 2 ;
 - 14 Coppie di coltelli B = 48 a = 5.5 ;
profilo 141 - 161A - 161B - 162 - 163A - 163B - 164A - 164B - 165A - 165B - 165C - 166A - 166B - 166C ;
 - 14 Coppie di relativi limitatori ;
 - 1 Pietra ad olio per l' affilatura ;
 - 1 Contenitore in materiale plastico.

K 397 - R

- Il set è composto da:
- 13 Coppie di coltelli B = 48 a = 5.5 ;
profilo 161A - 161B - 162 - 163A - 163B - 164A - 164B - 165A - 165B - 165C - 166A - 166B - 166C ;
 - 13 Coppie di relativi limitatori ;
 - 1 Pietra ad olio per l' affilatura ;
 - 1 Contenitore in materiale plastico.



ART

d

COD. SET

K397 - C	30	K397C09730
K397 - C	31.75	K397C09731
K397 - C	35	K397C09735
K397 - C	40	K397C11740
K397 - C	50	K397C11750
K397 - R		K397R00000



Set multi - profile K 397 - C.

- The set includes :
- 1 Cutter head Art K 394-T Z = 2;
 - 14 Pairs of knives B = 48 a = 5.5
ref. 141 - 161A - 161B - 162 - 163A - 163B - 164A - 164B - 165A - 165B - 165C - 166A - 166B - 166C;
 - 14 Pairs of chip - limitors ;
 - 1 Sharpening oil stone ;
 - 1 Plastic case.

Set multi - profile K 397 - R.

- The set includes :
- 13 Pairs of knives B = 48 a = 5.5
ref. 161A - 161B - 162 - 163A - 163B - 164A - 164B - 165A - 165B - 165C - 166A - 166B - 166C;
 - 13 Pairs of chip - limitors ;
 - 1 Sharpening oil stone;
 - 1 Plastic case.



Estuche multiperfiles K 397 - C.

- El juego comprende :
- 1 Cabezal Art K 394-T Z = 2;
 - 14 Pares de cuchillas B = 48 a = 5.5
ref. 141 - 161A - 161B - 162 - 163A - 163B - 164A - 164B - 165A - 165B - 165C - 166A - 166B - 166C;
 - 14 Pares de limitadores ;
 - 1 Afiladora;
 - 1 Estuche de plàstica.

Estuche multiperfiles K 397 - R.

- El juego comprende :
- 13 Pares de cuchillas B = 48 a = 5.5
ref. 161A - 161B - 162 - 163A - 163B - 164A - 164B - 165A - 165B - 165C - 166A - 166B - 166C;
 - 13 Pares de limitadores ;
 - 1 Afiladora;
 - 1 Estuche de plàstica.



Coffret multiprofiles K 397 - C.

- Le jeu comprend :
- 1 Porte - outils Art K 394-T Z = 2;
 - 14 Paires de couteaux B = 48 a = 5.5
réf. 141 - 161A - 161B - 162 - 163A - 163B - 164A - 164B - 165A - 165B - 165C - 166A - 166B - 166C;
 - 14 Paires de limiteurs ;
 - 1 Pierre à l' huile pour l' affûtage;
 - 1 Coffret en plastique.

Coffret multiprofiles K 397 - R.

- Le jeu comprend :
- 13 Paires de couteaux B = 48 a = 5.5
réf. 161A - 161B - 162 - 163A - 163B - 164A - 164B - 165A - 165B - 165C - 166A - 166B - 166C;
 - 13 Paires de limiteurs ;
 - 1 Pierre à l' huile pour l' affûtage;
 - 1 Coffret en plastique.



Multi - Profil Satz K 397 - C.

- Der Satz besteht aus :
- 1 Messerkopf Art K 394-T Z = 2;
 - 14 Messerpaaren B = 48 a = 5.5
Profil 141 - 161A - 161B - 162 - 163A - 163B - 164A - 164B - 165A - 165B - 165C - 166A - 166B - 166C;
 - 14 Abweiserpaaren ;
 - 1 Schleifölstein;
 - 1 Plastiketui.

Multi - Profil Satz K 397 - R.

- Der Satz besteht aus :
- 13 Messerpaaren B = 48 a = 5.5
Profil 161A - 161B - 162 - 163A - 163B - 164A - 164B - 165A - 165B - 165C - 166A - 166B - 166C;
 - 13 Abweiserpaaren ;
 - 1 Scheifhölstein;
 - 1 Plastiketui.



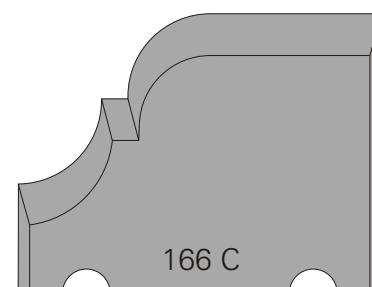
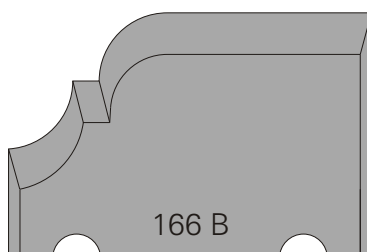
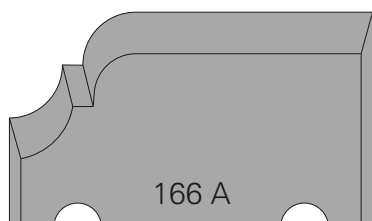
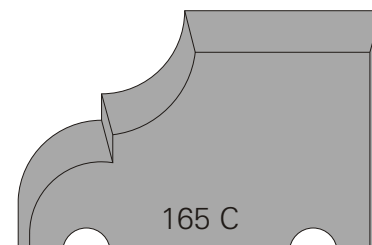
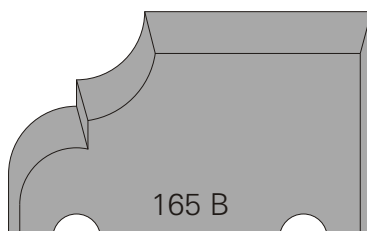
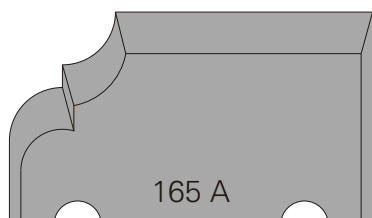
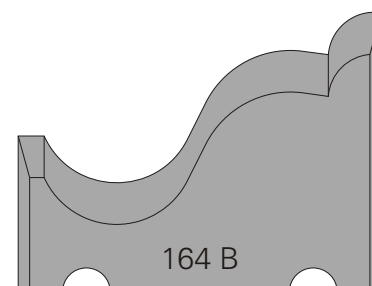
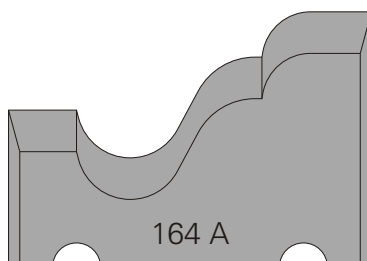
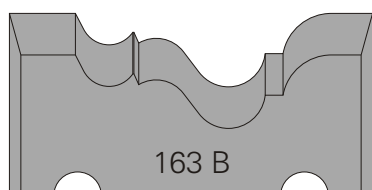
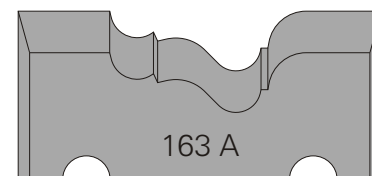
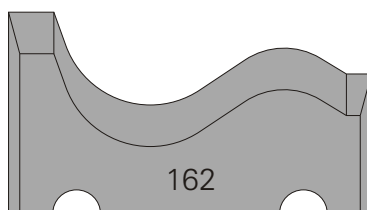
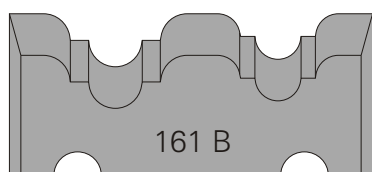
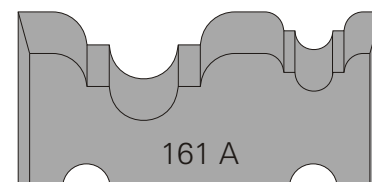
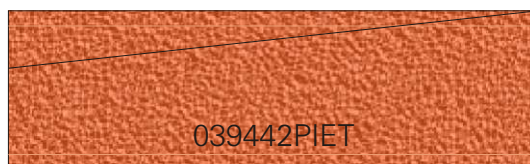
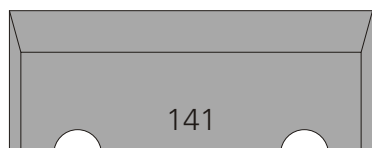
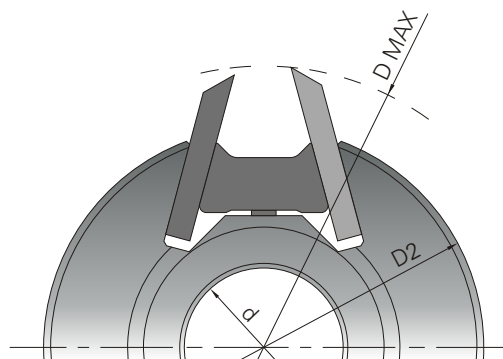

d	D2	D MAX
30	97	146
31.75	97	146
35	97	146
40	117	167
50	117	167

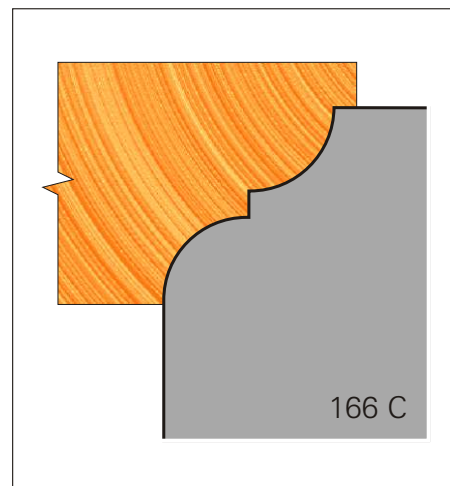
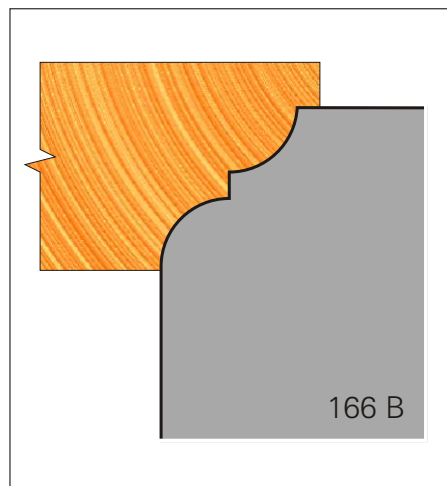
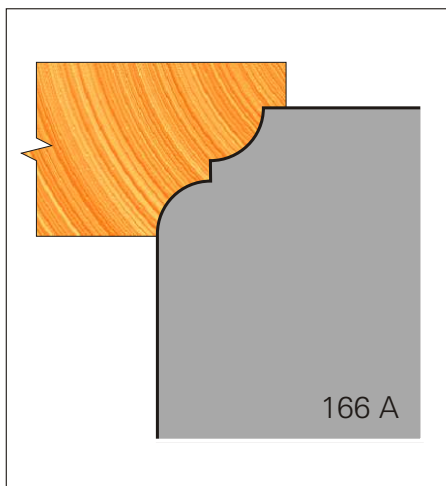
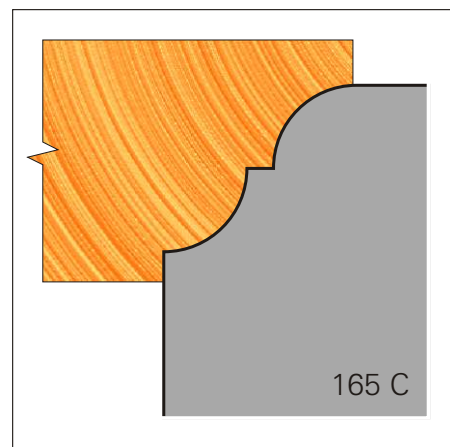
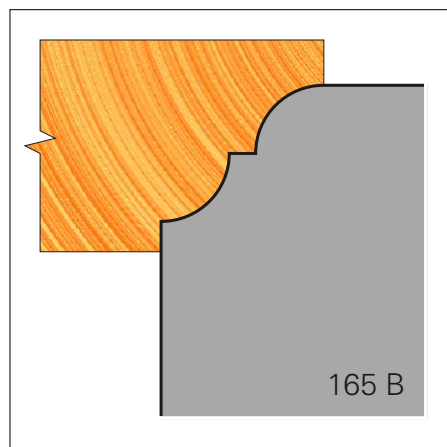
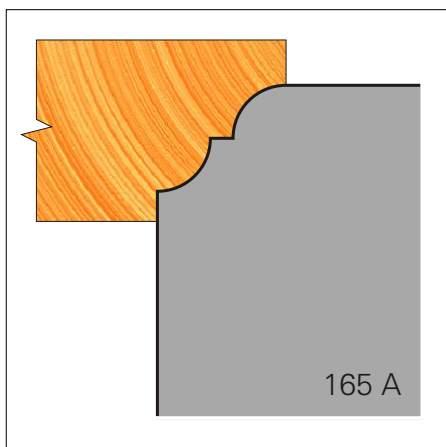
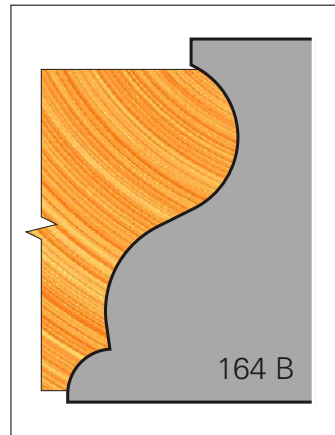
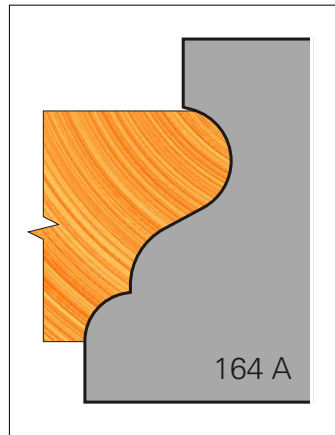
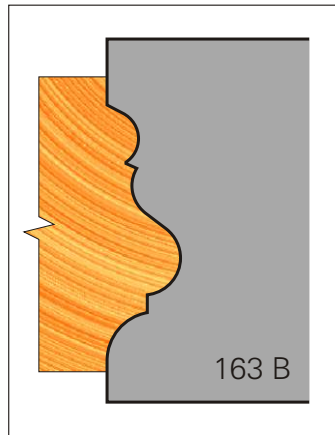
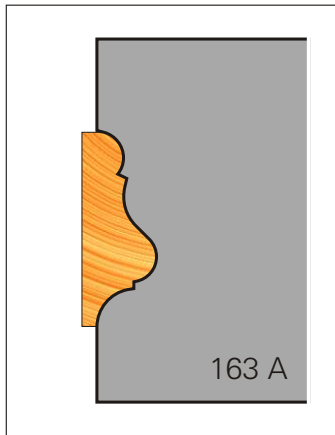
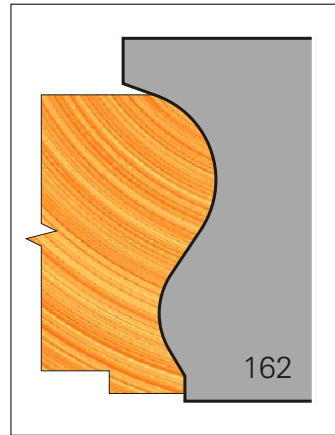
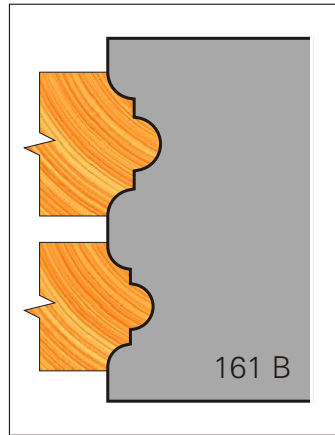
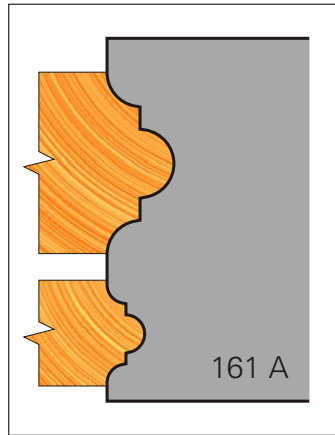
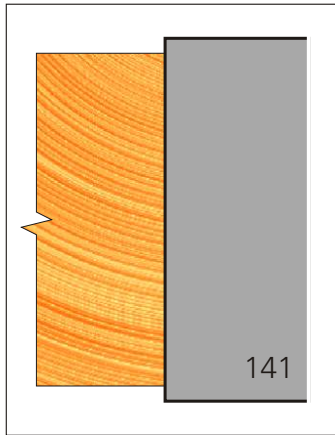



 Examples of workable profiles.

 Ejemplos de perfiles realizables.

 Exemples de profils réalisables.

 Durchführbaren Profilbeispiele.